

# Schubladenschränke | Breite / Width 440 mm x Tiefe / Depth 610 mm

## Drawer cabinets | Produktmerkmale / Product characteristics

### Merkmale / Characteristics



### Schrankgehäusehöhen / Nutzhöhen für den Einbau von Schubladen

#### Cabinet housing heights / Effective heights for the assembly of drawers

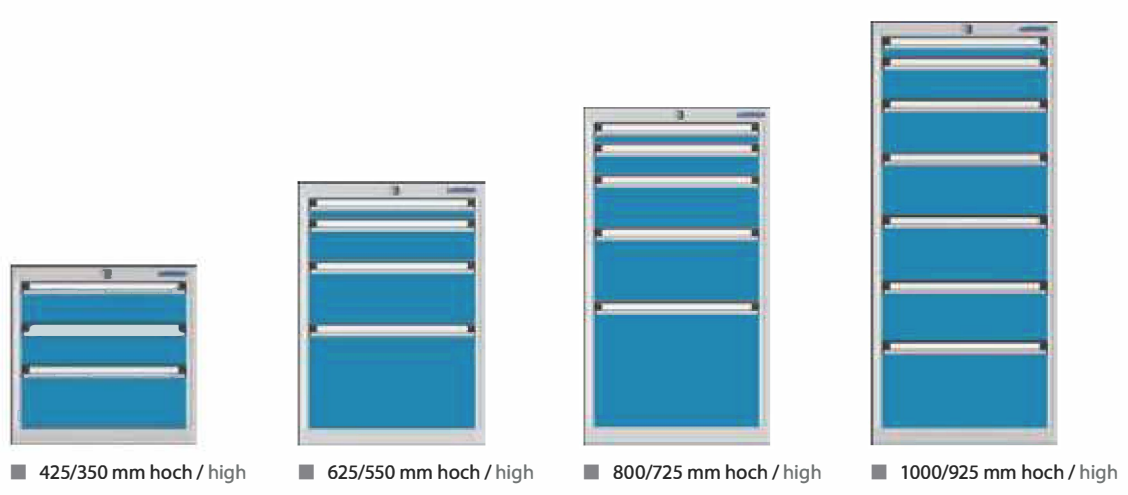

### Nutzmaße der Schubladen / Effective size of drawers

Blendenhöhe der Schubladen (mm) Drawer face height (mm)	Nutzhöhe der Schubladen (mm) Drawer effective height (mm)	Nutzfläche (Breite x Tiefe mm) Effective space (Width x Depth mm)
50	35	340 x 526
75	60	340 x 526
100	85	340 x 526
125	110	340 x 526
150	135	340 x 526
175	160	340 x 526
200	185	340 x 526
250	235	340 x 526
300	285	340 x 526

### Nutzfläche im 17 mm Raster Effective space in 17 mm grid

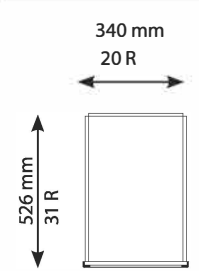

Raster (17 mm je Rastereinheit) erleichtern es Ihnen, die passenden Lagerkästen, Schlitzwand-sätze oder Muldensätze für die Schubladengröße zusammen zu stellen.

Grids (17 mm per unit) make it easier for you to arrange the matching storage boxes, slotted panel sets and trough sets for your drawer size.

Die Summe der Schubladenblendenhöhen muss der Nutzhöhe des Schrankgehäuses entsprechen.  
The sum of all drawer face heights must be equal to the useable front height of the cabinet housing.

# Schubladenschränke | Breite / Width 440 mm x Tiefe / Depth 610 mm

## Drawer cabinets | Bestellbeispiele / Order examples

### Höhe / Height 425 mm (Nutzhöhe / eff. height 350 mm)



50 Teilauszug / Part pull-out  
100  
200

3x



100  
100  
150

3x

Auszug / Pullout	Best.-Nr. / Ord.-No.
Teilauszug / Part pull-out	00.07.9245
Vollauszug (außer Blendenhöhe 50 mm) Full pull-out (except face height 50 mm)	00.07.9246

Auszug / Pull-out	Best.-Nr. / Ord.-No.
Teilauszug / Part pull-out	00.07.9247
Vollauszug / Full pull-out	00.07.9248

### Höhe / Height 625 mm (Nutzhöhe / eff. height 550 mm)

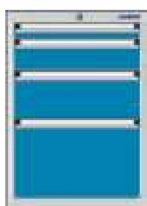

50 Teilauszug / Part pull-out  
100  
150  
250

4x

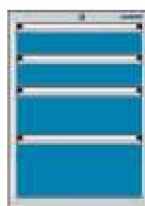

100  
100  
150  
200

4x

Auszug / Pullout	Best.-Nr. / Ord.-No.
Teilauszug / Part pull-out	00.07.9222
Vollauszug (außer Blendenhöhe 50 mm) Full pull-out (except face height 50 mm)	00.07.9208

Auszug / Pull-out	Best.-Nr. / Ord.-No.
Teilauszug / Part pull-out	00.07.9209
Vollauszug / Full pull-out	00.07.9210

### Höhe / Height 625 mm (Nutzhöhe / eff. height 550 mm)

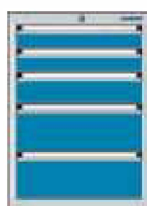

75  
75  
100  
150  
150

5x

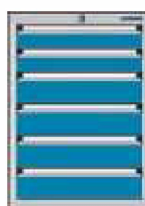

75  
75  
100  
100  
100  
100

6x

Auszug / Pull-out	Best.-Nr. / Ord.-No.
Teilauszug / Part pull-out	00.07.9211
Vollauszug / Full pull-out	00.07.9212

Auszug / Pull-out	Best.-Nr. / Ord.-No.
Teilauszug / Part pull-out	00.07.9249
Vollauszug / Full pull-out	00.07.9250

**Schubladenschränke**

Drawer cabinets

**Breite / Width 440 mm x Tiefe / Depth 610 mm**

Schubladeneinteilungssätze / Drawer partitioning sets

**Höhe / Height 800 mm (Nutzhöhe / eff. height 725 mm)**75  
75  
75  
100  
100  
150  
150

7x

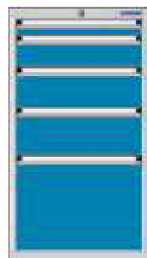
50 Teilauszug / Part pull-out  
100  
125  
150  
300

5x

Auszug / Pull-out	Best.-Nr. / Ord-No.
Teilauszug / Part pull-out	00.07.9239
Vollauszug / Full pull-out	00.07.9240

Auszug / Pull-out	Best.-Nr. / Ord-No.
Teilauszug / Part pull-out	00.07.9201
Vollauszug (außer Blendenhöhe 50 mm) Full pull-out (except face height 50 mm)	00.07.9202

**Höhe / Height 800 mm (Nutzhöhe / eff. height 725 mm)**50 Teilauszug / Part pull-out  
75  
200  
200  
200

5x

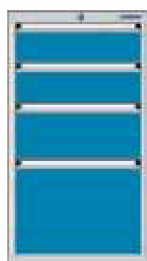
125  
125  
175  
300

4x

Auszug / Pull-out	Best.-Nr. / Ord-No.
Teilauszug / Part pull-out	00.07.9203
Vollauszug (außer Blendenhöhe 50 mm) Full pull-out (except face height 50 mm)	00.07.9204

Auszug / Pull-out	Best.-Nr. / Ord-No.
Teilauszug / Part pull-out	00.07.9205
Vollauszug / Full pull-out	00.07.9206

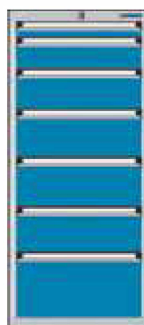
**Höhe / Height 1000 mm (Nutzhöhe / eff. height 925 mm)**50 Teilauszug / Part pull-out  
100  
125  
150  
150  
150  
200

7x

100  
100  
125  
200  
200  
200

6x

Auszug / Pull-out	Best.-Nr. / Ord-No.
Teilauszug / Part pull-out	00.07.9262
Vollauszug (außer Blendenhöhe 50 mm) Full pull-out (except face height 50 mm)	00.07.9263

Auszug / Pull-out	Best.-Nr. / Ord-No.
Teilauszug / Part pull-out	00.07.9264
Vollauszug / Full pull-out	00.07.9265

# Schubladenschränke

Drawer cabinets

**Breite / Width 440 mm x Tiefe / Depth 610 mm**

Zubehör / Accessories

## Abrollrand / 3-sided roller tray



- 3-seitig aufgekantetes Stahlblech, gefalzt
- Vernietet
- 3-sided roller tray, folded steel sheet
- Riveted

Breite / Width x Tiefe / Depth x Höhe / Height (mm)	Best.-Nr. / Ord.-no.
440 x 610 x 30	00.07.9194

## Abdeckplatten / Cover plates



- Lichtgraue Melaminharzbeschichtung
- Allseitig mit stoßfestem Kunststoffumleimer
- Verschraubbar
- Light-grey melamin resin coating
- All side with shockproof synthetic edging
- Can be screwed in

Breite / Width x Tiefe / Depth x Höhe / Height (mm)	Best.-Nr. / Ord.-no.
440 x 610 x 19	34.07.9192

## Feinriefenmatte / Fine grooved mat



- Qualität SBR
- Schwarz
- Auch als separate Auflage nutzbar
- Quality SBR
- Black
- Can be used separately

Breite / Width x Tiefe / Depth x Höhe / Height (mm)	Best.-Nr. / Ord.-no.
437 x 609 x 3	35.07.9195

## Gehäuse-Sockel / Housing base



- Gehäusesockel als Höhenausgleich, Höhe: 50 mm oder 100 mm, Tiefe 610 mm
- Housing base to balance height, height: 50 mm oder 100 mm, depth 610 mm

Sockel / Base	Höhe (mm) / Height (mm)	Breite (mm) / Width (mm)	Best.-Nr. / Ord.-no.
Gehäuse-Sockel / Housing base	50	440	00.07.9189
Gehäuse-Sockel / Housing base	100	440	00.07.9190



## Schubladerschränke | Breite / Width 440 mm x Tiefe / Depth 610 mm

### Drawer cabinets | Schubladeneinteilungssätze / Drawer partitioning sets

#### Schlitzwandsätze / Slotted panel sets



- 1 Schlitzwand 525 mm
- 2 Trennwände 167 mm 10 R
- 1 Slotted panel 525 mm
- 2 Dividers 167 mm 10 R



- 2 Schlitzwände 525 mm
- 1 Trennwand 99 mm 6 R
- 2 Trennwände 116 mm 7 R
- 2 Slotted panels 525 mm
- 1 Divider 99 mm 6 R
- 2 Dividers 116 mm 7 R

Blendenhöhen / Face heights	Best.-Nr. / Ord.-no.
50 mm	00.07.9251
75 mm	00.07.9252
100, 125 mm	00.07.9253
150, 175 mm	00.07.9254
200 mm	00.07.9255

Blendenhöhen / Face heights	Best.-Nr. / Ord.-no.
50 mm	00.07.9256
75 mm	00.07.9257
100, 125 mm	00.07.9258
150, 175 mm	00.07.9259

#### Einsatzkastensatz / Insert boxes set



- 12 Einsatzkästen EK 1 54 x 54 x 45 rot
- 4 Einsatzkästen EK 5 75 x 81 x 45 grün
- 2 Einsatzkästen EK 4 54 x 162 x 45 blau
- 3 Einsatzkästen EK 6 108 x 108 x 45 blau
- 3 Einsatzkästen EK 7 108 x 162 x 45 grün

- 12 insert boxes EK 1 54 x 54 x 45 red
- 4 insert boxes EK 5 75 x 81 x 45 green
- 2 insert boxes EK 4 54 x 162 x 45 blue
- 3 insert boxes EK 6 108 x 108 x 45 blue
- 3 insert boxes EK 7 108 x 162 x 45 green

Blendenhöhe / Face height	Best.-Nr. / Ord.-no.
75 mm	01.07.9261

#### Muldensatz aus Aluminium / Aluminum troughs



- 6 Mulden 518 x 55 mm
- 24 Steckbleche 43 mm breit
- Muldenhöhe 35 mm
- 6 troughs 518 x 55 mm
- 24 metal inserts 43 mm wide
- Trough height 35 mm

Blendenhöhe / Face height	Best.-Nr. / Ord.-no.
75 mm	00.07.9271

#### Zellkautschuk-Einlagen / Foam rubber inserts



- Zellkautschuk-Einlage für die Lagerung empfindlicher Messzeuge und Lehren
- Qualität EPDM, schwarz
- Breite 338 mm x Tiefe 525 x Dicke 3 mm
- Für alle Blendenhöhen
- Foam rubber mat for storage of sensitive measuring tools and calipers
- Quality EPDM, black
- Width 338 mm x Depth 525 x Thickness 3 mm
- For all face heights



- Ablagefach für Messzeuge, verschiebbar
- Breite 329 mm x Tiefe 304 mm x Höhe 20 mm
- Storage tray for measuring tools, adjustable
- Width 329 mm x Depth 304 mm x Height 20 mm

Best.-Nr. / Ord.-no.
27.07.9276

Blendenhöhen / Face heights	Best.-Nr. / Ord.-no.
75, 100, 125 mm	00.07.9280

# Schubladenschränke | Breite / Width 565 x Tiefe / Depth 728 mm

## Drawer cabinets | Produktmerkmale / Product characteristics

### Merkmale / Characteristics



- 
- 
- 
- 
- 
- 
- 
- 
- 
- 
- 
- 

### Schrankgehäusehöhen / Nutzhöhen für den Einbau von Schubladen

#### Cabinet housing heights / Effective heights for the assembly of drawers



425/325 mm hoch  
high



625/525 mm hoch  
high

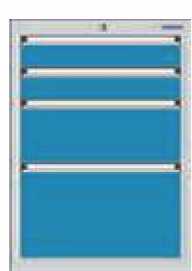

800/700 mm hoch  
high

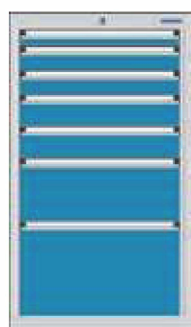

1000/900 mm hoch  
high

### Nutzmaße der Schubladen / Effective size of drawers

Blendenhöhe der Schubladen (mm) Drawer face height (mm)	Nutzhöhe der Schubladen (mm) Drawer effective height (mm)	Nutzfläche (Breite x Tiefe mm) Effective space (Width x Depth mm)
50	35	459 x 612
75	60	459 x 612
100	85	459 x 612
125	110	459 x 612
150	135	459 x 612
175	160	459 x 612
200	185	459 x 612
250	235	459 x 612
300	285	459 x 612

#### Nutzfläche im 17 mm Raster Effective space in 17 mm grid

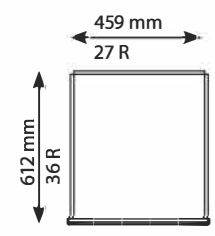

Raster (17 mm je Rastereinheit) erleichtern es Ihnen, die passenden Lagerkästen, Schlitzwand-sätze oder Muldensätze für die Schubladengröße zusammen zu stellen.

Die Summe der Schubladenblendenhöhen muss der Nutzhöhe des Schrankgehäuses entsprechen.  
Beispiel: 9 x Blendenhöhe 50 mm + 1 x Blendenhöhe 75 mm = Nutzhöhe 525 mm  
The sum of all drawer face heights must be equal to the useable front height of the cabinet housing.  
Example: 9 x face height 50 mm + 1 x face height 75 mm = effective height 525 mm

Grids (17 mm per unit) make it easier for you to arrange the matching storage boxes, slotted panel sets and trough sets for your drawer size.



# Schubladenschränke

Drawer cabinets

**Breite / Width 565 x Tiefe / Depth 728 mm**

Bestellbeispiele / Order examples

## Höhe / Height 425 mm (Nutzhöhe / Eff. height 325 mm)



75  
100  
150

3x

Auszug/Pull out	Best.-Nr./Ord. no.
Teilauszug / Part pull-out	00.02.9502
Vollauszug / Full pull-out	00.02.9503

## Höhe / Height 625 mm (Nutzhöhe / Eff. height 525 mm)



75  
100  
150  
200

4x

Auszug/Pull out	Best.-Nr./Ord. no.
Teilauszug / Part pull-out	00.02.9506
Vollauszug / Full pull-out	00.02.9507

## Höhe / Height 800 mm (Nutzhöhe / Eff. height 700 mm)

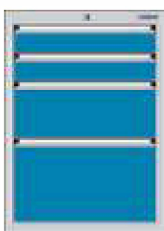

100  
100  
200  
300

4x

Auszug/Pull out	Best.-Nr./Ord. no.
Teilauszug / Part pull-out	00.02.9516
Vollauszug / Full pull-out	00.02.9517



100  
100  
150  
150  
200

5x

Auszug/Pull out	Best.-Nr./Ord. no.
Teilauszug / Part pull-out	00.02.9518
Vollauszug / Full pull-out	00.02.9519

## Höhe / Height 800 mm (Nutzhöhe / Eff. height 700 mm)

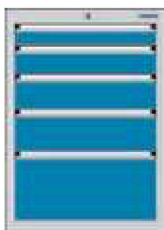

75  
100  
125  
150  
250

5x

Auszug/Pull out	Best.-Nr./Ord. no.
Teilauszug / Part pull-out	00.02.9526
Vollauszug / Full pull-out	00.02.9527

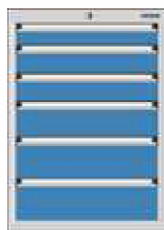

75  
100  
100  
125  
150  
150

6x

Auszug/Pull out	Best.-Nr./Ord. no.
Teilauszug / Part pull-out	00.02.9554
Vollauszug / Full pull-out	00.02.9555

**Schubladenschränke** | Breite / Width 565 x Tiefe / Depth 728 mm

Drawer cabinets | Bestellbeispiele / Order examples

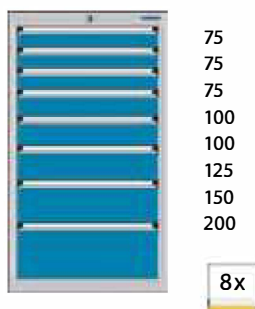
**Höhe / Height 1000 mm (Nutzhöhe / Eff. height 900 mm)**

8x

Auszug/Pull out	Best.-Nr./Ord. no.
Teilauszug / Part pull-out	00.02.9564
Vollauszug / Full pull-out	00.02.9565

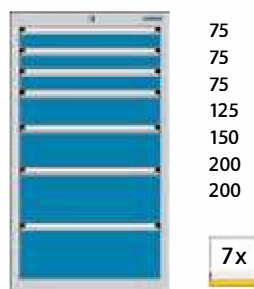

7x

Auszug/Pull out	Best.-Nr./Ord. no.
Teilauszug / Part pull-out	00.02.9534
Vollauszug / Full pull-out	00.02.9535

**Fahrbar / Mobile: Gehäusehöhe / Height 625 mm, Nutzhöhe / Eff. height 525 mm, Gesamthöhe mit Rollen / Overall height with castors 782 mm**

(Rollen / Castors Ø 100 mm) Gesamtgew. / Total weight max. 450 kg

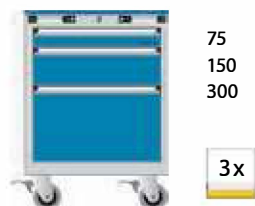

3x

- Abrollrand mit Feinriefenmatte
- Jede Schublade mit Einzelverriegelung
- 2 Lenk- und 2 Bockrollen
- Roller tray with fine grooved mat
- Drawers with individual drawer interlock
- 2 swivel castors and 2 fixed castors

Auszug / Pull-out	Best.-Nr. / Ord.-no.
Teilauszug / Part pull-out	00.02.9508
Vollauszug / Full pull-out	00.02.9509

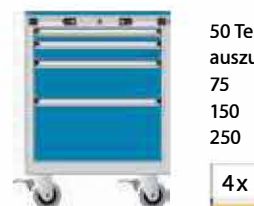

4x

- Abrollrand mit Feinriefenmatte
- Jede Schublade mit Einzelverriegelung
- 2 Lenk- und 2 Bockrollen
- Roller tray with fine grooved mat
- Drawers with individual drawer interlock
- 2 swivel castors and 2 fixed castors

Auszug / Pull-out	Best.-Nr. / Ord.-no.
Teilauszug / Part pull-out	00.02.9512
Vollauszug (außer Blendenhöhe 50 mm) Full pull-out (ex. face height 50 mm)	00.02.9513

**Fahrbar / Mobile: Gehäusehöhe / Height 800 mm, Nutzhöhe / Eff. height 700 mm, Gesamthöhe mit Rollen / Overall height with castors 986 mm**

(Rollen / Castors Ø 125 mm) Gesamtgew. / Total weight max. 750 kg

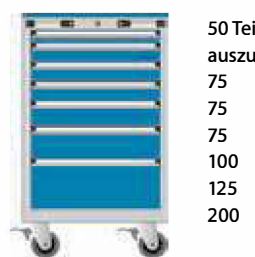
50 Teil-  
auszug

7x

- Abrollrand mit Feinriefenmatte
- Jede Schublade mit Einzelverriegelung
- 2 Lenk- und 2 Bockrollen
- Roller tray with fine grooved mat
- Drawers with individual drawer interlock
- 2 swivel castors and 2 fixed castors

Auszug / Pull-out	Best.-Nr. / Ord.-no.
Teilauszug / Part pull-out	00.02.9528
Vollauszug (außer Blendenhöhe 50 mm) Full pull-out (ex. face height 50 mm)	00.02.9529



5x

- Abrollrand mit Feinriefenmatte
- Jede Schublade mit Einzelverriegelung
- 2 Lenk- und 2 Bockrollen
- Roller tray with fine grooved mat
- Drawers with individual drawer interlock
- 2 swivel castors and 2 fixed castors

Auszug / Pull-out	Best.-Nr. / Ord.-no.
Teilauszug / Part pull-out	00.02.9530
Vollauszug / Full pull-out	00.02.9531



# Schubladenschränke

Drawer cabinets

**Breite / Width 565 x Tiefe / Depth 728 mm**

Zubehör / Accessories

## Abrollrand / 3-sided roller tray



- 3-seitig aufgekantetes Stahlblech, gefalzt
- Vernietet
- 3-sided roller tray, folded steel sheet
- Riveted

Breite / Width x Tiefe / Depth x Höhe / Height (mm)	Best.-Nr. / Ord.-no.
565 x 728 x 30	00.02.8310

## Abdeckplatten / Cover plates



- Lichtgraue Melaminharzbeschichtung
- Allseitig mit stoßfestem Kunststoffumleimer
- Verschraubbar
- Light-grey melamin resin coating
- All side with shockproof synthetic edging
- Can be screwed in

Breite / Width x Tiefe / Depth x Höhe / Height (mm)	Best.-Nr. / Ord.-no.
565 x 728 x 19	34.02.9541

## Feinriefenmatte / Fine grooved mat

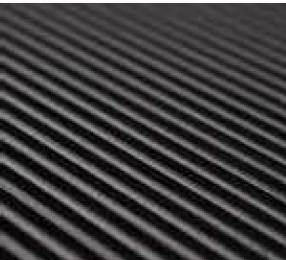

- Qualität SBR
- Schwarz
- Auch als separate Auflage nutzbar
- Quality SBR
- Black
- Can be used separately

Breite / Width x Tiefe / Depth x Höhe / Height (mm)	Best.-Nr. / Ord.-no.
562 x 727 x 3	35.02.9542

## Gehäuse-Sockel / Housing base



- Gehäusesockel als Höhenausgleich, Höhe: 50 mm oder 100 mm, Tiefe 728 mm
- Housing base to balance height, height: 50 mm oder 100 mm, depth 728 mm

Sockel Base	Höhe (mm) Height (mm)	Breite (mm) Width (mm)	Best.-Nr. Ord.-no.
Gehäuse-Sockel Housing base	50	565	00.02.8311
Gehäuse-Sockel Housing base	100	565	00.02.8312



# Schubladenschränke | Breite / Width 565 x Tiefe / Depth 728 mm

## Drawer cabinets | Schubladeneinteilungssätze / Drawer partitioning sets

### Schlitzwandsätze / Slotted panel sets

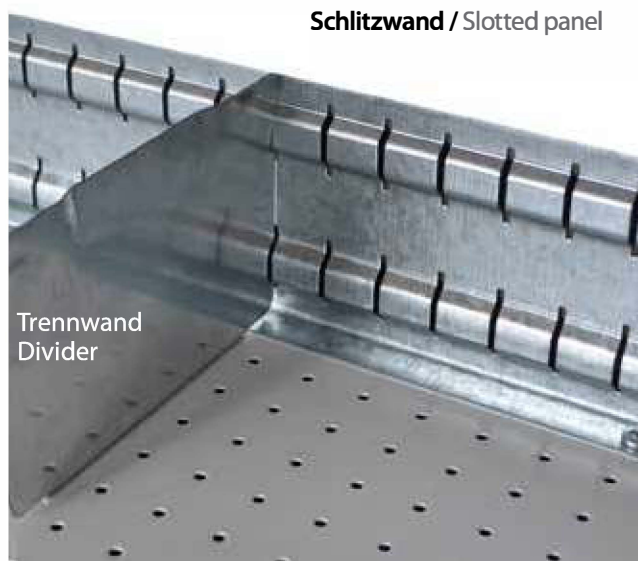

Schlitzwand / Slotted panel



- 1 Schlitzwand 610 mm, 36 R
- 2 Trennwände 201 mm, 12 R
- 2 Trennwände 252 mm, 15 R
- 1 Slotted panel 610 mm, 36 R
- 2 Dividers 201 mm, 12 R
- 2 Dividers 252 mm, 15 R

Blendenhöhen / Face heights	Best.-Nr. / Ord.-no.
50 mm	00.02.9598
75 mm	00.02.9599
100, 125 mm	00.02.9600
150, 175 mm	00.02.9601
200 mm	00.02.9602



- 2 Schlitzwände 610 mm, 36 R
- 9 Trennwände 150 mm, 9 R
- 2 Slotted panels 610 mm, 36 R
- 9 Dividers 150 mm, 9 R

Blendenhöhen / Face heights	Best.-Nr. / Ord.-no.
50 mm	00.02.9603
75 mm	00.02.9604
100, 125 mm	00.02.9605
150, 175 mm	00.02.9606



- 3 Schlitzwände 610 mm, 36 R
- 9 Trennwände 116 mm, 7 R
- 3 Trennwände 99 mm, 6 R
- 3 Slotted panels 610 mm, 36 R
- 9 Dividers 116 mm, 7 R
- 3 Dividers 99 mm, 6 R

Blendenhöhen / Face heights	Best.-Nr. / Ord.-no.
50 mm	00.02.9607
75 mm	00.02.9608
100, 125 mm	00.02.9609
150, 175 mm	00.02.9610

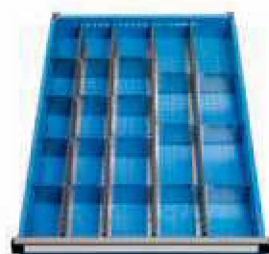

- 4 Schlitzwände 610 mm, 36 R
- 10 Trennwände 99 mm, 6 R
- 4 Trennwände 82 mm, 5 R
- 4 Trennwände 65 mm, 4 R
- 4 Slotted panels 610 mm, 36 R
- 10 Dividers 99 mm, 6 R
- 4 Dividers 82 mm, 5 R
- 4 Dividers 65 mm, 4 R

Blendenhöhen / Face heights	Best.-Nr. / Ord.-no.
50 mm	00.02.9611
75 mm	00.02.9612
100, 125 mm	00.02.9613



- 2 Schlitzwände 610 mm, 36 R
- 3 Trennwände 150 mm, 9 R
- 2 Slotted panels 610 mm, 36 R
- 3 Dividers 150 mm, 9 R

Blendenhöhen / Face heights	Best.-Nr. / Ord.-no.
50 mm	00.02.9614
75 mm	00.02.9615
100, 125 mm	00.02.9634
150, 175 mm	00.02.9635

# Schubladenschränke

Drawer cabinets

**Breite / Width 565 x Tiefe / Depth 728 mm**

Schubladeneinteilungssätze / Drawer partitioning sets

## Muldensätze aus Polypropylen-Kunststoff / Polypropylene troughs



- 12 Mulden 4-teilig
- 50 Steckwände 4-teilig
- 12 troughs four-part
- 50 trough inserts four-part

Blendenhöhe / Face height	Best.-Nr. / Ord.-no.
50 mm , 75 mm	00.02.9626



- 4 Mulden 4-teilig
- 20 Steckwände 4-teilig
- 8 Mulden 3-teilig
- 10 Steckwände 3-teilig
- 4 troughs four-part
- 20 trough inserts four-part
- 8 troughs three-part
- 10 trough inserts three-part

Blendenhöhe / Face height	Best.-Nr. / Ord.-no.
75 mm	00.02.9628



- 4 Mulden 3-teilig
- 20 Steckwände 3-teilig
- 8 Mulden 2-teilig
- 10 Steckwände 2-teilig
- 4 troughs three-part
- 20 trough inserts three-part
- 8 troughs two-part
- 10 trough inserts two-part

Blendenhöhe / Face height	Best.-Nr. / Ord.-no.
75 mm	00.02.9630

## Steckwände/Etiketten / Archiving labels & clear plastic strips

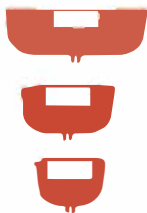

- Steckwände mit Beschriftungsfeld
- Etiketten/Klarsichtfolie: Breite 27,5 x Höhe 12,5 mm
- Trough inserts with labelling space
- Labels/Clear plastic strips: Width 27,5 x Height 12,5 mm

Ausführung / Characteristics	Best.-Nr. / Ord.-no.
73 mm breit / wide	00.02.1834
48 mm breit / wide	00.02.1832
36 mm breit / wide	00.02.1830
Beschriftungs-Etiketten (VE 25 St) Archiving labels	00.02.1841
Klarsichtfolie für Etiketten (VE 25 St) Clear plastic strips for archiving labels	00.02.1846

## Muldensatz aus Aluminium / Aluminum troughs



- 3 Mulden 602 x 55 mm
- 4 Mulden 602 x 73 mm
- 15 Steckbleche 43 mm
- 20 Steckbleche 62 mm
- Muldenhöhe 35 mm
- 3 troughs 602 x 55 mm
- 4 troughs 602 x 73 mm
- 15 metal insert 43 mm
- 20 metal insert 62 mm
- troughs height 35 mm

Blendenhöhe / Face height	Best.-Nr. / Ord.-no.
75 mm	00.02.9629

**Schubladenschränke** | Breite / Width 565 x Tiefe / Depth 728 mm

Drawer cabinets

Schubladeneinteilungssätze / Drawer partitioning sets

## Lagerkastensätze / Insert boxes sets



- 16 Einsatzkästen 75 x 75 x 26/46 mm
- 8 Einsatzkästen 150 x 75 x 26/46 mm
- 4 Einsatzkästen 150 x 150 x 26/46 mm
- 16 insert boxes 75 x 75 x 26/46 mm
- 8 insert boxes 150 x 75 x 26/46 mm
- 4 insert boxes 150 x 150 x 26/46 mm

Blendenhöhen / Face heights	Best.-Nr. / Ord.-no.
50 mm	00.02.9622
75 mm	00.02.9623



- 16 Einsatzkästen 75 x 75 x 26/46 mm
- 16 Trennwände einsteckbar
- 16 Einsatzkästen 75 x 75 x 26/46 mm
- 4 Einsatzkästen 150 x 75 x 26/46 mm
- 2 Einsatzkästen 150 x 150 x 26/46 mm
- 16 insert boxes 75 x 75 x 26/46 mm
- 16 Dividers are insertable
- 16 insert boxes 75 x 75 x 26/46 mm
- 4 insert boxes 150 x 75 x 26/46 mm
- 2 insert boxes 150 x 150 x 26/46 mm

Blendenhöhen / Face heights	Best.-Nr. / Ord.-no.
50 mm	00.02.9624
75 mm	00.02.9625

## Zellkautschuk-Einlagen / Foam rubber inserts



- Zellkautschuk-Einlage für die Lagerung empfindlicher Messzeuge und Lehren
- Qualität EPDM, schwarz
- Breite 457 mm x Tiefe 610 x Dicke 3 mm
- Für alle Blendenhöhen

- Foam rubber insert for storing delicate measuring and gauges
- Quality EPDM, black
- Width 457 mm x Depth 610 x Thickness 3 mm
- For all face heights

Best.-Nr. / Ord.-no.
27.02.9631

## AQURADO® - Modulares Ordnungssystem / Modular filing system



- AQURADO®-System bestehend aus: 16 Universalboxen, 3 Ausgleichsboxen, Klebepad, AQURADO®-Platte
- Breite 456 mm x Tiefe 600 mm x Höhe 52 mm
- AQURADO® system consisting of: 16 all-purpose boxes, 3 adjusting boxes, sticky pad, AQURADO® board
- Width 456 mm x Depth 600 mm x Height 52 mm

Blendenhöhen / Face heights	Best.-Nr. / Ord.-no.
Ab / From 75 mm	45.02.0072



- AQURADO®-System bestehend aus: 10 Universalboxen, 3 Ausgleichsboxen, Klebepad, AQURADO®-Platte
- Breite 456 mm x Tiefe 600 mm x Höhe 52 mm
- AQURADO® system consisting of: 10 all-purpose boxes, 3 adjusting boxes, sticky pad, AQURADO® board
- Width 456 mm x Depth 600 mm x Height 52 mm

Blendenhöhen / Face heights	Best.-Nr.
Ab / From 75 mm	45.02.0073



# Schubladenschränke | Breite / Width 576 x Tiefe / Depth 610 mm

## Drawer cabinets | Produktmerkmale / Product characteristics

### Merkmale / Characteristics



### Schrankgehäusehöhen / Nutzhöhen für den Einbau von Schubladen

#### Cabinet housing heights / Effective heights for the assembly of drawers

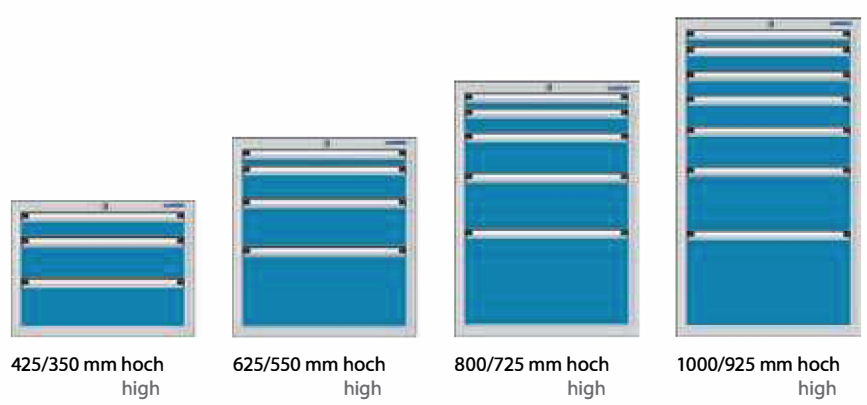

### Nutzmaße der Schubladen / Effective size of drawers

Blendenhöhe der Schubladen (mm) Drawer face height (mm)	Nutzhöhe der Schubladen (mm) Drawer effective height (mm)	Nutzfläche (Breite x Tiefe mm) Effective space (Width x Depth mm)
50	35	475 x 526
75	60	475 x 526
100	85	475 x 526
125	110	475 x 526
150	135	475 x 526
175	160	475 x 526
200	185	475 x 526
250	235	475 x 526
300	285	475 x 526

Nutzfläche im 17 mm Raster  
Effective space in 17 mm grid

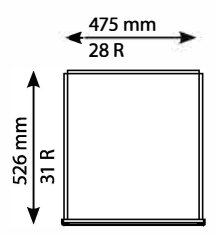

Raster (17 mm je Rastereinheit) erleichtern es Ihnen, die passenden Lagerkästen, Schlitzwand-sätze oder Muldensätze für die Schubladengröße zusammen zu stellen.

Die Summe der Schubladenblendenhöhen muss der Nutzhöhe des Schrankgehäuses entsprechen.  
Beispiel: 11 x Schubladenblendenhöhe 50 mm = Nutzhöhe 550 mm  
The sum of all drawer face heights must be equal to the useable front height of the cabinet housing.  
Example: 11 x Drawer face height 50 mm = Effective height 550 mm

Grids (17 mm per unit) make it easier for you to arrange the matching storage boxes, slotted panel sets and trough sets for your drawer size.

# Schubladenschränke | Breite / Width 576 x Tiefe / Depth 610 mm

Drawer cabinets

Bestellbeispiele / Order examples

Höhe / Height 425 mm (Nutzhöhe / Eff. height 350 mm)



75  
125  
150

3x

Auszug/Pull out	Best.-Nr./Ord. no.
Teilauszug / Part pull-out	00.05.2309
Vollauszug / Full pull-out	00.05.9208

Höhe / Height 625 mm (Nutzhöhe / Eff. height 550 mm)

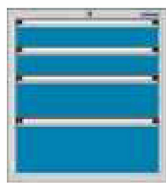

100  
100  
150  
200

4x

Auszug/Pull out	Best.-Nr./Ord. no.
Teilauszug / Part pull-out	00.05.2307
Vollauszug / Full pull-out	00.05.9210

Höhe / Height 800 mm (Nutzhöhe / Eff. height 725 mm)



100  
125  
200  
300

4x

Auszug/Pull out	Best.-Nr./Ord. no.
Teilauszug / Part pull-out	00.05.9215
Vollauszug / Full pull-out	00.05.9216



100  
125  
150  
150  
200

5x

Auszug/Pull out	Best.-Nr./Ord. no.
Teilauszug / Part pull-out	00.05.9217
Vollauszug / Full pull-out	00.05.9218

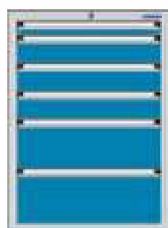

50 Teilauszug / Part pull-out  
100  
100  
100  
175  
200

6x

Auszug/Pull out	Best.-Nr./Ord. no.
Teilauszug / Part pull-out	00.05.9331
Vollauszug (außer Blendenhöhe 50 mm) Full pull-out (ex. face height 50 mm)	00.05.9332



75  
100  
150  
150  
250

5x

Auszug/Pull out	Best.-Nr./Ord. no.
Teilauszug / Part pull-out	00.05.9333
Vollauszug / Full pull-out	00.05.9334



## Schubladenschränke | Breite / Width 576 x Tiefe / Depth 610 mm

### Drawer cabinets | Bestellbeispiele / Order examples

Höhe / Height 1000 mm (Nutzhöhe / Eff. height 925 mm)

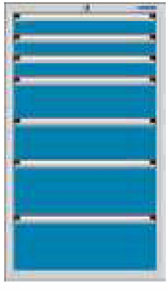

75  
75  
75  
150  
150  
200  
200

**7x**

Auszug/Pull out	Best.-Nr./Ord. no.
Teilauszug / Part pull-out	00.02.8184
Vollauszug / Full pull-out	00.05.9338



75  
100  
200

550  
(Tür)  
(Door)

**3x**

- Einschließlich ein Verstell- und Ausgleichsboden verzinkt
- Including a adjustable shelf and a bottom shelf, galvanized

Auszug/Pull out	Best.-Nr./Ord. no.
Teilauszug / Part pull-out	00.02.8194
Vollauszug / Full pull-out	00.05.9340

Fahrbar / Mobile: Gehäusehöhe / Height 625 mm, Nutzhöhe / Eff. height 550 mm, Gesamthöhe mit Rollen / Overall height with castors 782 mm

(Rollen / Castors Ø 100 mm) Gesamtgew. / Total weight max. 450 kg

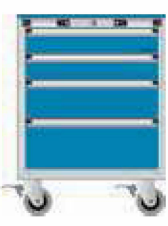

100  
100  
150  
200

**4x**

- Abrollrand mit Feinriefenmatte
- Jede Schublade mit Einzelverriegelung
- 2 Lenk- und 2 Bockrollen
- Roller tray with fine grooved mat
- Drawers with individual drawer interlock
- 2 swivel castors and 2 fixed castors

Auszug / Pull-out	Best.-Nr. / ord.-no.
Teilauszug / Part pull out	00.05.8924
Vollauszug / Full pull-out	00.05.9213



50 Teil-  
auszug  
100  
150  
250

**4x**

- Abrollrand mit Feinriefenmatte
- Jede Schublade mit Einzelverriegelung
- 2 Lenk- und 2 Bockrollen
- Roller tray with fine grooved mat
- Drawers with individual drawer interlock
- 2 swivel castors and 2 fixed castors

Auszug / Pull-out	Best.-Nr./Ord. no.
Teilauszug / Particle pull-out	00.05.8925
Vollauszug (außer Blendenhöhe 50 mm) Full pull-out (ex. face height 50 mm)	00.05.9212

Fahrbar / Mobile: Gehäusehöhe / Height 800 mm, Nutzhöhe / Eff. height 725 mm, Gesamthöhe mit Rollen / Overall height with castors 986 mm

(Rollen / Rolls Ø 125 mm) Gesamtgew. / Total weight max. 750 kg

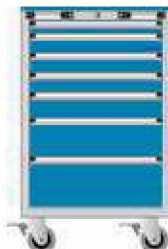

50 Teil-  
auszug  
75  
75  
75  
100  
150  
200

**7x**

- Abrollrand mit Feinriefenmatte
- Jede Schublade mit Einzelverriegelung
- 2 Lenk- und 2 Bockrollen
- Roller tray with fine grooved mat
- Drawers with individual drawer interlock
- 2 swivel castors and 2 fixed castors

Auszug / Pull-out	Best.-Nr. / Ord.-no.
Teilauszug / Part Pull-out	00.05.8928
Vollauszug (außer Blendenhöhe 50 mm) Full pull-out (ex. face height 50 mm)	00.05.9335



75  
100  
100  
150  
300

**5x**

- Abrollrand mit Feinriefenmatte
- Jede Schublade mit Einzelverriegelung
- 2 Lenk- und 2 Bockrollen
- Roller tray with fine grooved mat
- Drawers with individual drawer interlock
- 2 swivel castors and 2 fixed castors

Auszug / Pull-out	Best.-Nr./Ord. no.
Teilauszug / Part pull-out	00.05.8929
Vollauszug / Full pull-out	00.05.9336

# Schubladenschränke | Breite / Width 576 x Tiefe / Depth 610 mm

## Drawer cabinets | Zubehör / Accessories

### Abrollrand / 3-sided roller tray



- 3-seitig aufgekantetes Stahlblech, gefalzt
- Vernietet
- 3-sided roller tray, folded steel sheet
- Riveted

Breite / Width x Tiefe / Depth x Höhe / Height (mm)	Best.-Nr. / Ord.-no.
576 x 610 x 30	00.02.8141

### Abdeckplatten / Cover plates



- Lichtgraue Melaminharzbeschichtung
- Allseitig mit stoßfestem Kunststoffumleimer
- Verschraubbar
- Light-grey melamin resin coating
- All side with shockproof synthetic edging
- Can be screwed in

Breite / Width x Tiefe / Depth x Höhe / Height (mm)	Best.-Nr. / Ord.-no.
576 x 610 x 19	34.02.8123

### Feinriefenmatte / Fine grooved mat

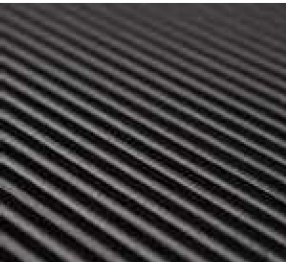

- Qualität SBR
- Schwarz
- Auch als separate Auflage nutzbar
- Quality SBR
- Black
- Can be used separately

Breite / Width x Tiefe / Depth x Höhe / Height (mm)	Best.-Nr. / Ord.-no.
573 x 609 x 3	35.02.8931

### Gehäuse-Sockel / Housing base



- Gehäusesockel als Höhenausgleich, Höhe: 50 mm oder 100 mm, Tiefe 610 mm
- Housing base to balance height, height: 50 mm oder 100 mm, depth 610 mm

Sockel / Base	Höhe (mm) / Height (mm)	Breite (mm) / Width (mm)	Best.-Nr. / Ord.-no.
Gehäuse-Sockel / Housing base	50	576	00.05.2310
Gehäuse-Sockel / Housing base	100	576	00.05.2311

RS  
440RS  
565RS  
576RS  
717RS  
1000RS  
1024RS  
1196RS  
1434Schubl.-  
regal

## Schubladenschränke | Breite / Width 576 x Tiefe / Depth 610 mm

Drawer cabinets | Schubladeneinteilungsätze / Drawer partition sets

### Schlitzwandsätze / Slotted panel sets

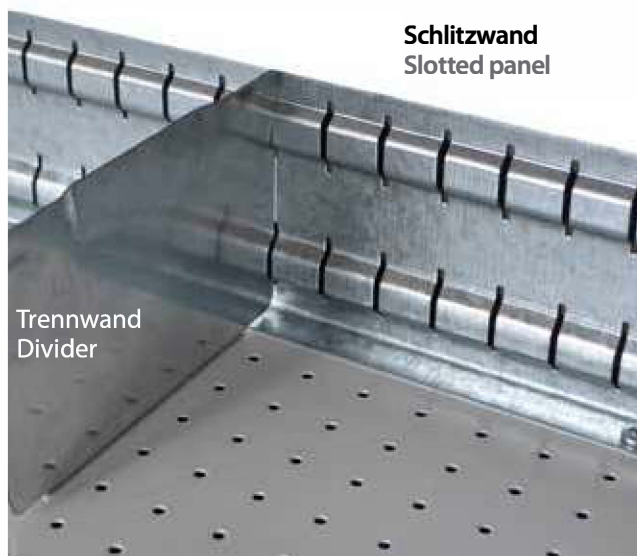

Schlitzwand  
Slotted panel



- 1 Schlitzwand 525 mm
- 4 Trennwände 235 mm
- 1 Slotted panel 525 mm
- 4 Dividers 235 mm

Blendenhöhen / Face heights	Best.-Nr. / Ord.-no.
50 mm	00.05.8951
75 mm	00.05.8952
100, 125 mm	00.05.8953
150, 175 mm	00.05.8954
200 mm	00.05.8955



- 2 Schlitzwände 525 mm
- 4 Trennwände 150 mm
- 2 Trennwände 167 mm
- 2 Slotted panels 525 mm
- 4 Dividers 150 mm
- 2 Dividers 167 mm

Blendenhöhen / Face heights	Best.-Nr. / Ord.-no.
50 mm	00.05.8956
75 mm	00.05.8957
100, 125 mm	00.05.8958
150, 175 mm	00.05.8959
200 mm	00.05.8960



- 3 Schlitzwände 525 mm
- 8 Trennwände 116 mm
- 3 Slotted panels 525 mm
- 8 Dividers 116 mm

Blendenhöhen / Face heights	Best.-Nr. / Ord.-no.
50 mm	00.05.8961
75 mm	00.05.8962
100, 125 mm	00.05.8963
150, 175 mm	00.05.8964



- 4 Schlitzwände 525 mm
- 6 Trennwände 82 mm
- 2 Trennwände 99 mm
- 2 Trennwände 116 mm
- 4 Slotted panels 525 mm
- 6 Dividers 82 mm
- 2 Dividers 99 mm
- 2 Dividers 116 mm

Blendenhöhen / Face heights	Best.-Nr. / Ord.-no.
50 mm	00.05.8966
75 mm	00.05.8967
100, 125 mm	00.05.8968



- 5 Schlitzwände 525 mm
- 20 Trennwände 82 mm
- 6 Trennwände 48 mm
- 5 Slotted panels 525 mm
- 20 Dividers 82 mm
- 6 Dividers 48 mm

Blendenhöhen / Face heights	Best.-Nr. / Ord.-no.
50 mm	00.05.8971
75 mm	00.05.8972

# Schubladenschränke

Drawer cabinets

**Breite / Width 576 x Tiefe / Depth 610 mm**

Schubladeneinteilungsätze / Drawer partition sets

## Schlitzwandsätze / Slotted panel sets



- 2 Schlitzwände 525 mm
- 2 Trennwände 201 mm
- 5 Trennwände 133 mm
- 2 Slotted panels 525 mm
- 2 Dividers 201 mm
- 5 Dividers 133 mm

Blendenhöhen / Face heights	Best.-Nr. / Ord.-no.
50 mm	00.05.8976
75 mm	00.05.8977
100, 125 mm	00.05.8978
150, 175 mm	00.05.9000
200 mm	00.05.9005

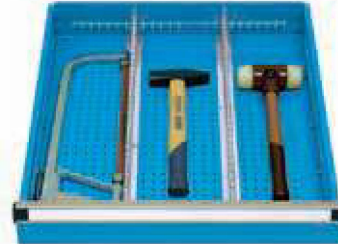

- 2 Schlitzwände 525 mm
- 2 Slotted panels 525 mm

Blendenhöhen / Face heights	Best.-Nr. / Ord.-no.
50 mm	00.05.9016
75 mm	00.05.9017
100, 125 mm	00.05.9018
150, 175 mm	00.05.9019
200, 250, 300, 400 mm	00.05.9020

## Lagerkastensätze / Insert boxes sets

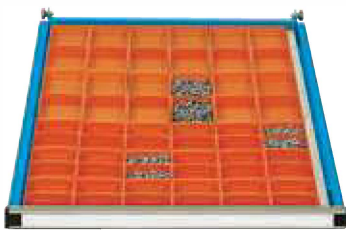

- 18 Einsatzkästen (75 x 75 x 26 mm)
- 12 Einsatzkästen (150 x 75 x 26 mm)
- 30 Trennwände steckbar
- 1 Ausgleichsleiste
- 18 insert boxes (75 x 75 x 26 mm)
- 12 insert boxes (150 x 75 x 26 mm)
- 30 Dividers insertable
- 1 Compensating strip

Blendenhöhe / Face height	Best.-Nr. / Ord.-no.
50 mm	00.05.8993



- 14 Einsatzkästen (75 x 75 x 26/46 mm)
- 8 Einsatzkästen (150 x 75 x 26/46 mm)
- 3 Einsatzkästen (150 x 150 x 26/46 mm)
- 1 Ausgleichsleiste
- 14 insert boxes (75 x 75 x 26/46 mm)
- 8 insert boxes (150 x 75 x 26/46 mm)
- 3 insert boxes (150 x 150 x 26/46 mm)
- 1 Compensating strip

Blendenhöhen / Face heights	Best.-Nr. / Ord.-no.
50 mm	00.05.8994
75 mm	00.05.8995

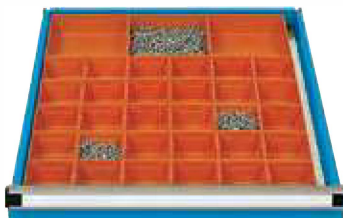

- 30 Einsatzkästen (75 x 75 x 26/46 mm)
- 3 Einsatzkästen (150 x 150 x 26/46 mm)
- 1 Ausgleichsleiste
- 30 insert boxes (75 x 75 x 26/46 mm)
- 3 insert boxes (150 x 150 x 26/46 mm)
- 1 Compensating strip

Blendenhöhen / Face heights	Best.-Nr. / Ord.-no.
50 mm	00.05.8996
75 mm	00.05.8997



- 9 Einsatzkästen (150 x 75 x 26/46/71 mm)
- 6 Einsatzkästen (150 x 150 x 26/46/71 mm)
- 1 Ausgleichsleiste
- 9 insert boxes (150 x 75 x 26/46/71 mm)
- 6 insert boxes (150 x 150 x 26/46/71 mm)
- 1 compensating strip

Blendenhöhen / Face heights	Best.-Nr. / Ord.-no.
50 mm	00.05.9001
75 mm	00.05.9002
100 mm	00.05.9003



RS  
440RS  
565RS  
576RS  
717RS  
1000RS  
1024RS  
1196RS  
1434Schubl.-  
regal

## Schubladenschränke | Breite / Width 576 x Tiefe / Depth 610 mm

### Drawer cabinets | Schubladeneinteilungssätze / Drawer partition sets

#### Muldensätze aus Aluminium / Aluminium trough sets



- 7 Mulden 518 x 55 mm
- 1 Mulde 518 x 73 mm
- 28 Steckbleche 43 mm breit
- 3 Steckbleche 62 mm breit
- Muldenhöhe 35 mm
- 7 troughs 518 x 55 mm
- 1 trough 518 x 73 mm
- 28 metal inserts 43 mm wide
- 3 metal inserts 62 mm wide
- Trough height 35 mm

Blendenhöhe / Face height

Best.-Nr. / Ord.-no

75 mm

00.05.9009



- 3 Mulden 518 x 55 mm
- 4 Mulden 518 x 73 mm
- 12 Steckbleche 43 mm breit
- 16 Steckbleche 62 mm breit
- Muldenhöhe 35 mm
- 3 troughs 518 x 55 mm
- 4 troughs 518 x 73 mm
- 12 metal inserts 43 mm wide
- 16 metal inserts 62 mm wide
- Trough height 35 mm

Blendenhöhe / Face height

Best.-Nr. / Ord.-no.

75 mm

00.05.9010

#### Zellkautschuk-Einlagen / Foam rubber inserts



- Zellkautschuk-Einlage für die Lagerung empfindlicher Messzeuge und Lehren
- Qualität EPDM, schwarz
- Breite 473 mm x Tiefe 525 x Dicke 3 mm
- Für alle Blendenhöhen

- Foam rubber insert for storing delicate measuring tools and gauges
- Quality EPDM, black
- Width 473 mm x Depth 525 x Thickness 3 mm, for all face heights

Best.-Nr. / Ord.-no.

27.05.9007



- Ablagefach mit Zellkautschuk-Einlage für Messzeuge (ohne Lagerkastensatz)
- Maße: Breite 473 x Tiefe 302 mm x Höhe 20 mm
- Verschiebbar

- Storage tray with rubber insert for measuring tools (without set of boxes)
- Width 473 x Depth 302 mm x Height 20 mm
- Adjustable

Blendenhöhen / Face heights

Best.-Nr. / Ord.-no.

75, 100, 125 mm

00.05.0928

#### AQRADO® - Modulares Ordnungssystem

Modular filing system



- AQRADO®-System bestehend aus: 4 Multiboxen, 8 Varioboxen, Inbusschlüsselbox, Messschieberbox, Klebepad, AQRADO®-Platte
- Breite 456 mm x Tiefe 504 mm x Höhe 52 mm

- AQRADO® system consisting of: 4 all-purpose boxes, 8 vario boxes, box for Allen keys, calliper box, sticky pad, AQRADO® board
- Width 456 mm x Depth 504 mm x Height 52 mm

Blendenhöhe / Face height

Best.-Nr. / Ord.-no.

Ab / From 75 mm

45.02.0065

#### Klemmleisten

Clamping strips

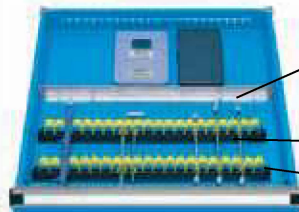

- Trennschiene für Blendenhöhe 50 mm: Effektive Höhe 32 mm, Länge 473 mm
- 2 Universal-Klemmleisten: 440 mm lang, mit 20 austauschbaren Kunststoffschlaufen, max. Klemmbereich Ø ca. 25 mm

- Divider for face height 50 mm: Effective height 32 mm, Length 473 mm
- 2 all-purpose clamping strips: 440 mm long, with 20 exchangeable plastic loops, max. clamping diameter Ø ca. 25 mm

Trennschiene für Blendenhöhe 50 mm  
Divider for face height 50 mm

Best.-Nr. / Ord.-no

Effektive Höhe 32 mm, Länge 473 mm  
Effective height 32 mm, Length 473 mm

00.05.9041

2 Stück Universal-Klemmleisten

Best.-Nr. / Ord.-no.

2 all-purpose clamping strips

59.05.9013